



Contents lists available at SCCE

Journal of Soft Computing in Civil Engineering

Journal homepage: [www.jsoftcivil.com](http://www.jsoftcivil.com)



## Design Optimization of Reinforced Concrete Waffle Slab Using Genetic Algorithm

S.O.A. Olawale<sup>1</sup>, O.P. Akintunde<sup>2\*</sup>, M.O. Afolabi<sup>2</sup>, M.A. Tijani<sup>1</sup>

1. Department of Civil Engineering, Faculty of Engineering, Osun State University, Osogbo, Nigeria

2. Department of Civil and Environmental Engineering, College of Engineering, Bells University of Technology, Ota, Nigeria

Corresponding author: [akintt18@gmail.com](mailto:akintt18@gmail.com)

<https://doi.org/10.22115/SCCE.2020.224460.1195>

### ARTICLE INFO

#### Article history:

Received: 25 March 2020

Revised: 22 August 2020

Accepted: 22 August 2020

#### Keywords:

Waffle slab;

Optimization;

Genetic algorithm;

Reinforced concrete design;

MATLAB EC2 (euro code 2).

### ABSTRACT

This research presents the optimization techniques for reinforced concrete waffle slab design because the EC2 code cannot provide an efficient and optimum design. Waffle slab is mostly used where there is necessity to avoid column interfering the spaces or for a slab with large span or as an aesthetic purpose. Design optimization has been carried out here with MATLAB, using genetic algorithm. The objective function include the overall cost of reinforcement, concrete and formwork while the variables comprise of the depth of the rib including the topping thickness, rib width, and ribs spacing. The optimization constraints are the minimum and maximum areas of steel, flexural moment capacity, shear capacity and the geometry. The optimized cost and slab dimensions are obtained through genetic algorithm in MATLAB. The optimum steel ratio is 2.2% with minimum slab dimensions. The outcomes indicate that the design of reinforced concrete waffle slabs can be effectively carried out using the optimization process of genetic algorithm.

## 1. Introduction

Concrete slabs produced from R.C comprising ribs spanning in two ways on its underneath are called waffle slabs. The network design which is shaped by the reinforcing beams result in the

How to cite this article: Olawale SOA, Akintunde OP, Afolabi MO, Tijani MA. Design optimization of reinforced concrete waffle slab using genetic algorithm. J Soft Comput Civ Eng 2020;4(2):46–62. <https://doi.org/10.22115/scce.2020.224460.1195>.

2588-2872/ © 2020 The Authors. Published by Pouyan Press.

This is an open access article under the CC BY license (<http://creativecommons.org/licenses/by/4.0/>).



name waffle. Waffle slabs are favored for lengths exceeding 12m and are much more desired compared to other types of slabs such as flat slabs with drop panels, flat slabs, two-way spanning slabs, one-way spanning slabs, and one-way beam slabs. Joists produce a pattern like surface at the soffit and a flat top in a waffle slab. The elimination of casts after the setting of the concrete produce the grid. Much rigidity and solidity are achieved in a structure which entails higher length and heftier loads. Structures that demand nominal vibration and large spaces require this type of waffle slabs due to their high stiffness. For instance, production buildings, libraries, theatres, stations and laboratories etc. Complicated formwork characterize waffle slabs construction, but based on the project and the volume of concrete required, it may be inexpensive to construct as compared with other types of slabs. Diverse ways are employed in the construction of waffle slabs but general process is required in order to assume the waffle shape. Vertical supports, waffle shells, horizontal supports, hollow plates, cube connections, clits and reinforcing bars constitute several components from which the formwork is made. The construction of the supports is followed by arrangement of the shells and final pouring of concrete.

Rows of concrete joists in orthogonal directions to each other characterize waffle slab construction. Shear reinforcements provision entails the use of solid head while even construction of depth demands the adoption solid wide beam sections. Appreciable decrease is permitted in the construction of waffle slab regarding the self-weight as associated to normal flab slab construction due to the possibility of reducing thickness of slab as a result of the small distance between the joists (PCA Notes on 318-05).

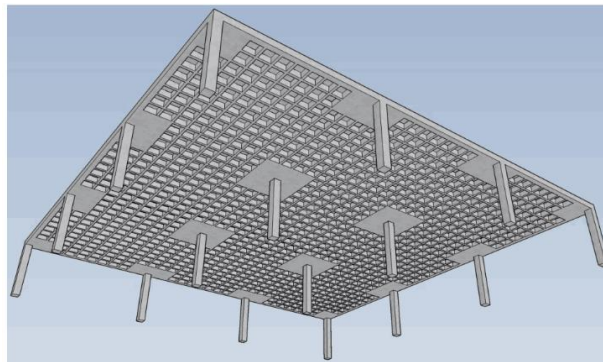

**Fig. 1.** Waffle slabs comprising solid heads.

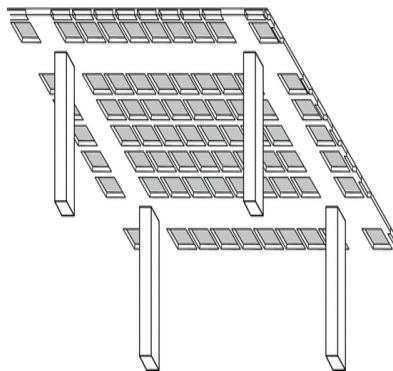

**Fig. 2.** Waffle slabs comprising band beams.

Optimizations of Non-linear R.C structures analysis and reinforced concrete design were presented by [1]. Reinforcement optimization was achieved using the process of Optimum Reinforced Concrete Highly Interactive Dimensioning (OPCHID). The optimization of concrete structures such as shear walls, beams, water tanks, slabs, frame structures, pipes columns, tensile components, bridges and folded plates was appraised by [2]. Reliability based design assessment was also involved in the study. The review suggested the necessity to have major structures optimized in terms of cost particularly high rise 3D structures comprising various complex members. Practicing engineers will draw immense benefits from the findings of the study no doubt. Optimization of Life-cycle of structures which has a reduced cost value in substitute to the original construction cost alone when related to the life-span cost necessitates further investigations on optimization. The specially tailored ORCHID (Optimum Reinforced Concrete Highly Interactive Dimensioning) program is used for the design and optimization of reinforcement.

R.C flat slab cost optimization according to the British Code of Practice (BS 8110) was investigated. Costs of reinforcement, formwork and concrete constituted the structural members' costs while the costs of the flooring, columns and foundations which made up the overall cost of the building formed the objective function. The distinct technique of the optimization of Hook and Jeeves was preceded the generic algorithm process adopted in universal probing [3]. One-way concrete slabs cost optimization based on current American Code of Practice (ACI 318-M08) was investigated. Absolute cost optimization of concrete and steel as demanded by the requirements of the code was carried out for the concrete slab using Particle Swarm Optimization (PSO) process which was arranged to cater for optimization problems without constraints [4]. A. kaveh *et al.* employed a varied complex penalty in resolving optimization problem associated to constraints. Universal equation model for single and multi-storey reinforced concrete slab optimization involving divers end restraints conditions according to ACI requirements was investigated [5].

Large pre-stressed concrete slabs were optimized using Particle Swarm Optimization Algorithm (PSO). Concurrent examination and utilization were supplied by these quantities which ultimately reduced the reliance of PSO on its coefficients [6]. Cuckoo search (CS) optimization technique, referred to as metaheuristic optimization as was introduced. The firsthand CS algorithm was confirmed with the aid of a non-linear standard limited optimization case after being merged with Le'vy flights. Thirteen (13) design issues confirmed in the reserved review to verify against optimization of engineering structures adopted the CS approach [7]. One-way R.C hollow slab arrangement was optimized in terms of cost. Objective function was the system cost and it was designed according to ACI 318-05 code of the American Concrete Institute. Harmony search algorithm was utilized in the reduction of this function provided the constraints of the design were satisfied [8].

Harmony- based search algorithm process for the optimization of unique seismic moment R.C frames subjected to earthquakes load according to America Standard Specifications was researched. Costs of reinforcing steel, concrete and formwork were designated as the overall

costs of frames and constituted the objective function [9]. R.C flat slabs cost optimization with random arrangement in asymmetrical high-rise structures was reviewed. The mixture accommodates various conditions involving voids or no voids, beams perimeter, columns perimeter and in-plane shear wall. Costs of steel, concrete, and construction combined to produce an overall cost function in a flat slab arrangements. Adeli and Park robust neural dynamics sample was employed to resolve the nonlinear optimization problem. The technique was adopted in the optimization of a 36- Storey building involving two flat slab samples. The process resulted in cost optimization of 6.7-9% and also automating the R.C slab design system [9]. The cost optimization of sheltered concrete beams according to ACI specifications and requirements using genetic algorithm was studied. Strength, ductility, durability, serviceability etc. requirements were adequately satisfied. The independent variables were the reinforcing steel dimensions which considered the flexural, torsion, torsion effects on the beams. Genetic algorithm forces, deformations and moments were determined by assessment. Comparison with the former review was made of the optimization results [10].

Investigative research on ribbed slabs optimization is very rare due to limited research in the area. The optimization of R.C flat slabs with drop panel constitutes one of the most significant reviews out of the paper investigated under this area. Costs of the material, labor, concrete, reinforcement and formwork constituted the cost of each of the structural members involved. Overall cost of structure which involved the costs of slab and column was defined as the objective function. Several grades of concrete and steel reinforcement were related and the optimized results established. With rise in the grades of concrete and reinforcement, slab cost was drastically heightened. The number of slab span was discovered to be directly related to slab optimum cost percentage reduction [11].

Genetic algorithm was employed in the optimization of the design of R.C waffle slabs. Two techniques of waffle slabs consisting band beams along columns centerlines and waffle slabs involving solid heads were examined using direct design approach for the analysis and design. Reinforcement, concrete and formwork costs constituted the objective function while effective slab depth, width of rib, thickness of slab top, and ribs spacing were adopted as the independent design variables. Ribs dimensions, steel reinforcement area required for flexure and minimum area, slab thickness constituted the design optimization constraints. MATLAB software was used in generating the algorithm and the in-built genetic algorithm toolbox was used to complete the optimization method [12].

## **2. Materials and Methods**

### **Determination of Constraints and Functions**

In order to proceed with the optimization, we need to determine the cost function or objective function, design variables and the constraints. The values of the design variable are needed for the reduction of cost, cost function is subjected to design constraints while keeping some parameters constant.

### 2.1. Width of the rib

The minimum rib width will be established by considering the cover, bar spacing and fire requirements. For this optimization, the ribs shall not be less than 100mm. (section 3.6 of BS 8110 part 1). Let  $x_3$  be the minimum rib width. The optimization constraints are given as  $g_1, g_2 \dots \dots \dots g_8$ .

$$x_3 \geq 100mm$$

$$g_1 = 0.1 - x_3 \leq 0 \quad (1)$$

The maximum rib width will also be established by considering the cover, bar spacing and fire requirements. For this optimization, the ribs shall not be more than 200mm.

(Section 3.6 of BS 8110 part 1)

$$x_3 \leq 250mm$$

$$g_2 = x_3 - 0.25 \leq 0 \quad (2)$$

### 2.2. Depth of the R.C waffle slab

The minimum depth of the reinforced concrete waffle slab (i.e. depth of the rib plus any topping thickness) should not be less than 300mm (section 3.6 of BS 8110 part 1). Let  $x_1$  be the minimum depth of the R.C. waffle slab.

$$x_1 \geq 300 \text{ mm}$$

$$g_3 = 0.3 - x_1 \leq 0 \quad (3)$$

The maximum depth of the reinforced concrete waffle slab (i.e. depth of the rib plus any topping thickness) should not be more than 600mm (section 3.6 of BS 8110 part 1). Let  $x_1$  be the maximum depth of the R.C. waffle slab.

$$x_1 \leq 600mm$$

$$g_4 = x_1 - 0.6 \leq 0 \quad (4)$$

### 2.3. Spacing between the ribs

The minimum clear space between the ribs should not be lower than 750mm (section 3.6 of BS 8110 part1). Let  $x_2$  be the minimum clear spacing between the ribs.

$$x_2 \geq 750mm$$

$$g_5 = 0.75 - x_2 \leq 0 \quad (5)$$

The maximum clear space between the ribs should not be greater than 1200mm (section 3.6 of BS 8110 part1). Let  $x_2$  be the maximum clear spacing between the ribs.

$$x_2 \leq 1200mm$$

$$g_6 = x_2 - 1.2 \leq 0 \quad (6)$$

## 2.4. Serviceability constraint

The minimum steel area as indicated by table 3.25 of BS 8110, which specifies 0.25%bh. Let  $\gamma$  be the minimum steel area.

$$\gamma \geq 0.0025$$

$$g_7 = 0.0025 - \gamma \leq 0 \quad (7)$$

The maximum steel area as indicated by table 3.12.6 of the BS 8110, which specifies 4%bh. Let  $x_4$  be the maximum steel area.

$$x_4 \leq 0.04$$

$$g_8 = \gamma - 0.04 \leq 0 \quad (8)$$

## 2.5. Flexural constraints

The total load on the slab is estimated in KN/m per ribs. All nominal flexural strength on the flanges between the rib (span) and the rib (support)  $M_{ns}$  and  $M_{nr}$  respectively, should be higher than the ultimate design moment at each of these parts of the slab  $M_{us}$  and  $M_{ur}$ .

$$M_{us} \leq M_{ns}$$

$$M_{ur} \leq M_{nr}$$

In the above equation, the ultimate design moment for both the span and the rib can be calculated as

$$M_{us} = Wl^2\alpha_s$$

$$M_{ur} = Wl^2\alpha_r$$

Where the coefficient of moment for the span and the rib ' $\alpha$ ' are gotten from table 3.13 and 3.14 of BS 8110

$$k_s = \frac{M_{us}}{x_2 x_1^2 f_{cu}}$$

$$k_r = \frac{M_{ur}}{x_3 x_1^2 f_{cu}}$$

$$k_s \leq 0.156$$

$$k_r \leq 0.156$$

$$g_9 = \frac{M_{us}}{x_2 x_1^2 f_{cu}} - 0.156 \leq 0 \quad (9)$$

$$g_{10} = \frac{M_{ur}}{x_3 x_1^2 f_{cu}} - 0.156 \leq 0 \quad (10)$$

## 2.6. Shear constraint

The shear force  $V$  is gotten from

$$V = WL\beta_{VX}$$

The design shear stress ( $v$ ) in  $\text{N/mm}^2$  will be calculated as

$$v = \frac{V}{x_1 x_3}$$

$$v < v_c$$

$$g_{11} = \frac{v}{x_1 x_3} - v_c < 0 \quad (11)$$

## 2.7. Design variables

Design variable are variable whose value are needed for optimization of cost. The design variable for this project will be the effective thickness of the slab (i.e. the summation of the depth of the rib and topping slab thickness), the spaces between the ribs, and the ribs width. And they are respectively denoted by  $x_1$ ,  $x_2$ , and  $x_3$ .

**Table 1**

Variables relationships with Lower and Upper boundaries.

Variables (mm)	Lower bound (mm)	Upper bound (mm)
$x_1$	300	600
$x_2$	750	1200
$x_3$	100	200

## 2.8. Objective function or fitness function

The cost function is a mathematical expression that represents the total cost essential for waffle slab construction and it depends on the cost of concrete used, the cost of formwork used in the precast process and the cost of reinforcement used to satisfy the tensile strength of concrete

$$f(x_1, x_2, x_3, x_4) = \left[ l_1 l_2 x_1 - \frac{(l_1 - x_2)(l_2 - x_2)x_3 x_1}{(x_3 + x_2)} \right] C_c' + \gamma l_1 l_2 x_1 \rho_s C_r' + (2(l_1 + l_2)x_1 + l_1 l_2) C_f' \quad (12)$$

## 2.9. Constant parameters

The parameters which are also the constants constitute the final necessities for the optimization problem. These parameter remain unchanged throughout the optimization process. In this project, the numerous parameters and values are engaged as defined in the table below. The values of the parameters that will be use are shown in Table 2 below.

**Table 2**

Given Parameters.

Parameters	Values
$l_1$	9.765m
$l_2$	12.025m
$f_{cu}$	25 N/mm <sup>2</sup>
$f_y$	mm <sup>2</sup>

### 3. Results and discussion

The built-in genetic algorithm of MATLAB is endowed with series of plot utilities to analyze the suitability of the design variable. The result of the variations of the fitness of cost function at various reinforcement ratio were displayed with the aid of the plot functions. Figures 3 to 14 show the plots of optimized function, variables and scores at several steel ratios. The same results are plotted with the variation of steel ratio in figures 15 to 18 for better interpretation. The optimized cost as shown in figure 15 shows spikes at various steel ratios but the trend is on the increase with steel ratio. In figure 16, the variation of the width of rib with steel ratio exhibits the minimum rib width of about 238mm at the steel ratio of 2.2%. The minimum depth of 350mm is exhibited past 3.2% of steel ratio in figure 17. The plot of rib spacing with steel ratio in figure 18 shows many spikes at various steel ratios. However, at steel ratio of 2.2% the minimum spacing of 750mm is obtained. It is clear that the optimized variables occurred at the steel ratio of 2.2%.

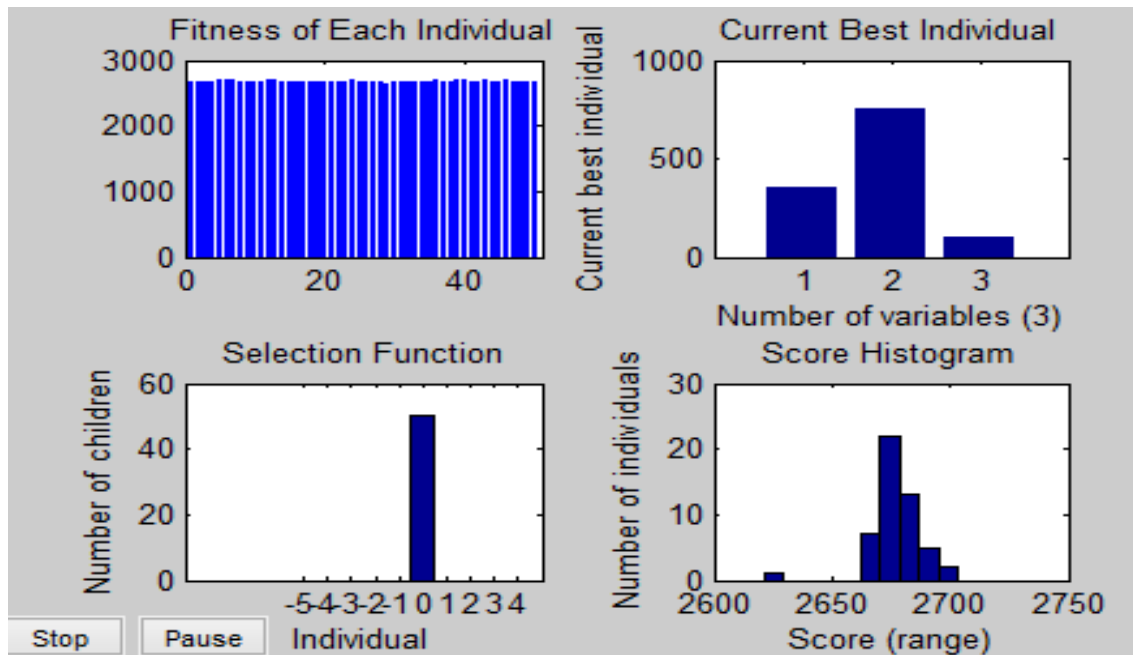

**Fig. 3.** Plots of optimization data for 0% reinforcement.



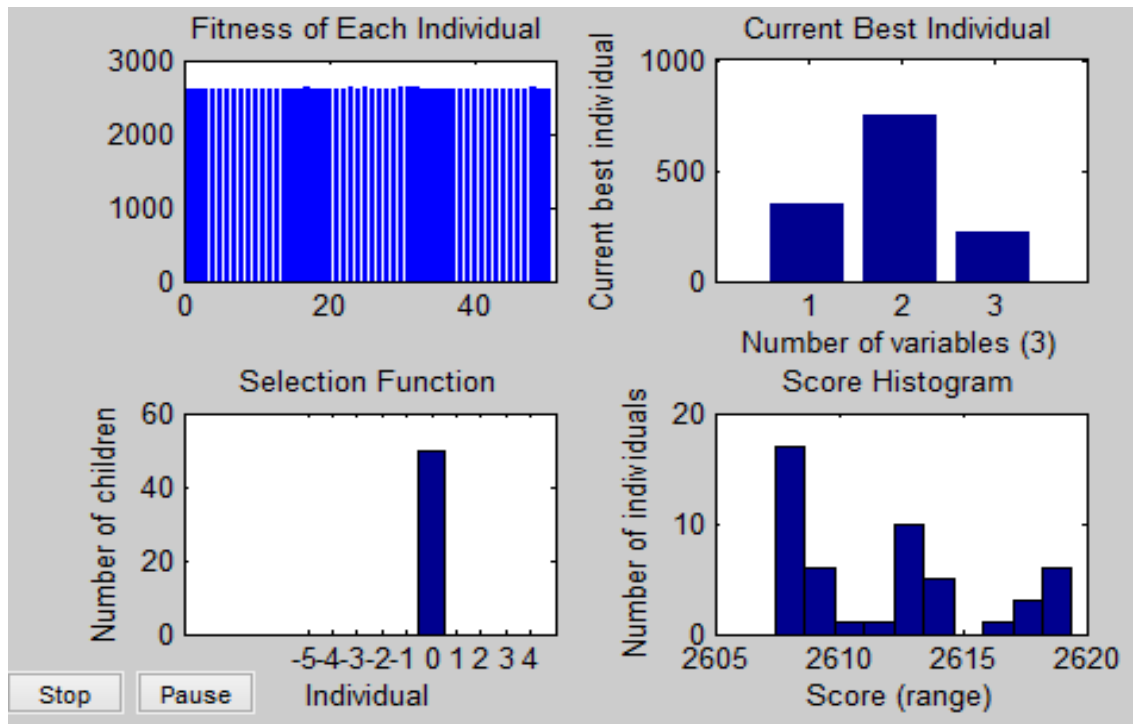

Fig. 4. Plots of optimization data for 0.25% reinforcement.

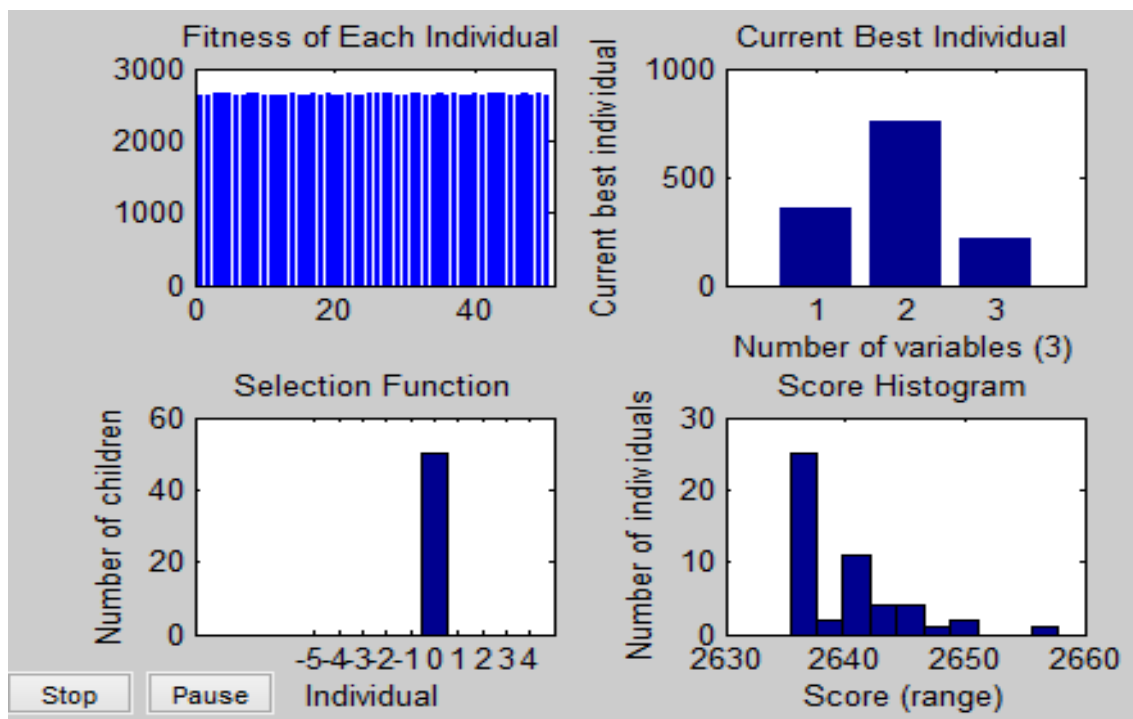

Fig. 5. Plots of optimization data for 0.5% reinforcement.

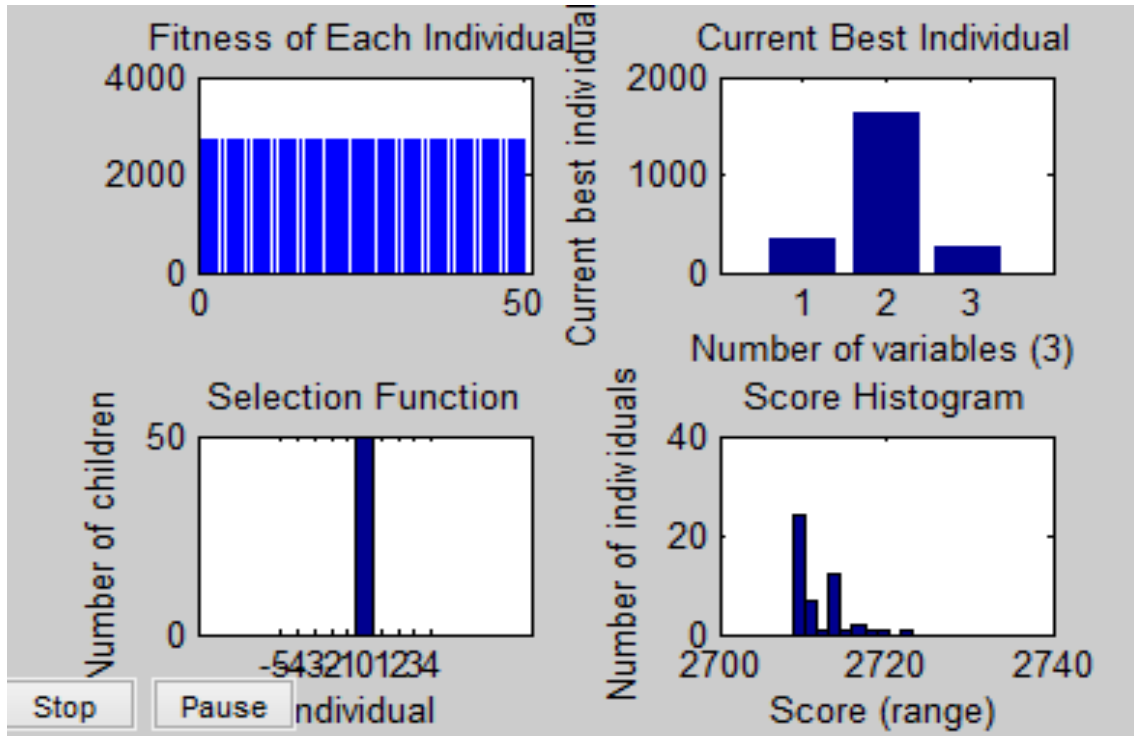

Fig. 6. Plots of optimization data for 1.0% reinforcement.

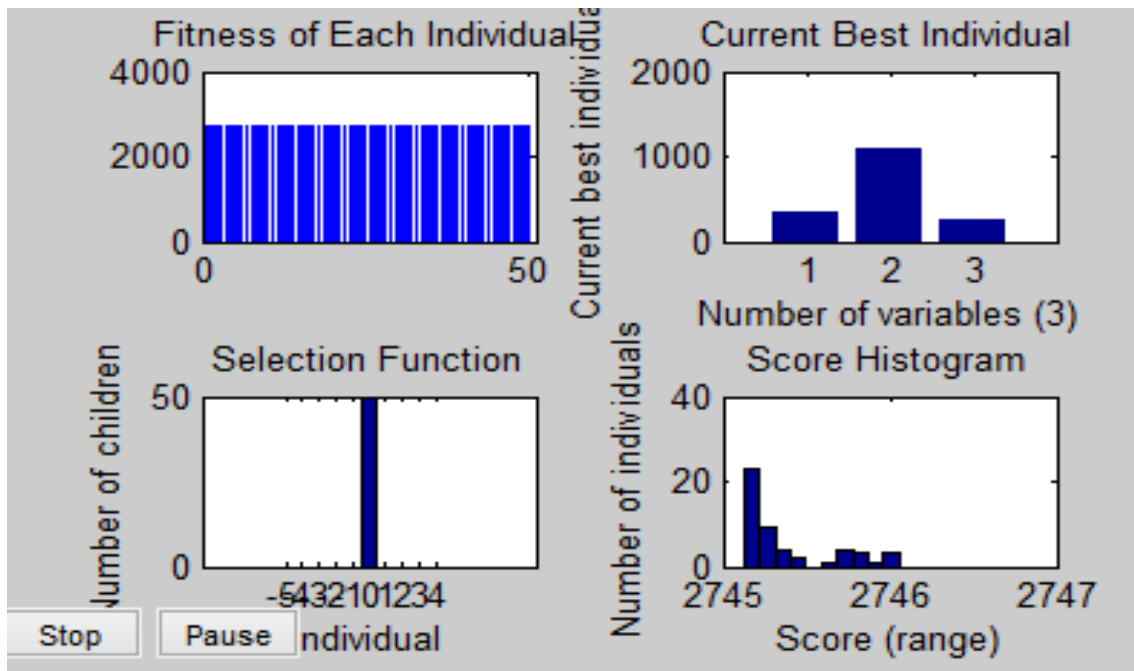

Fig. 7. Plots of optimization data for 1.5% reinforcement.

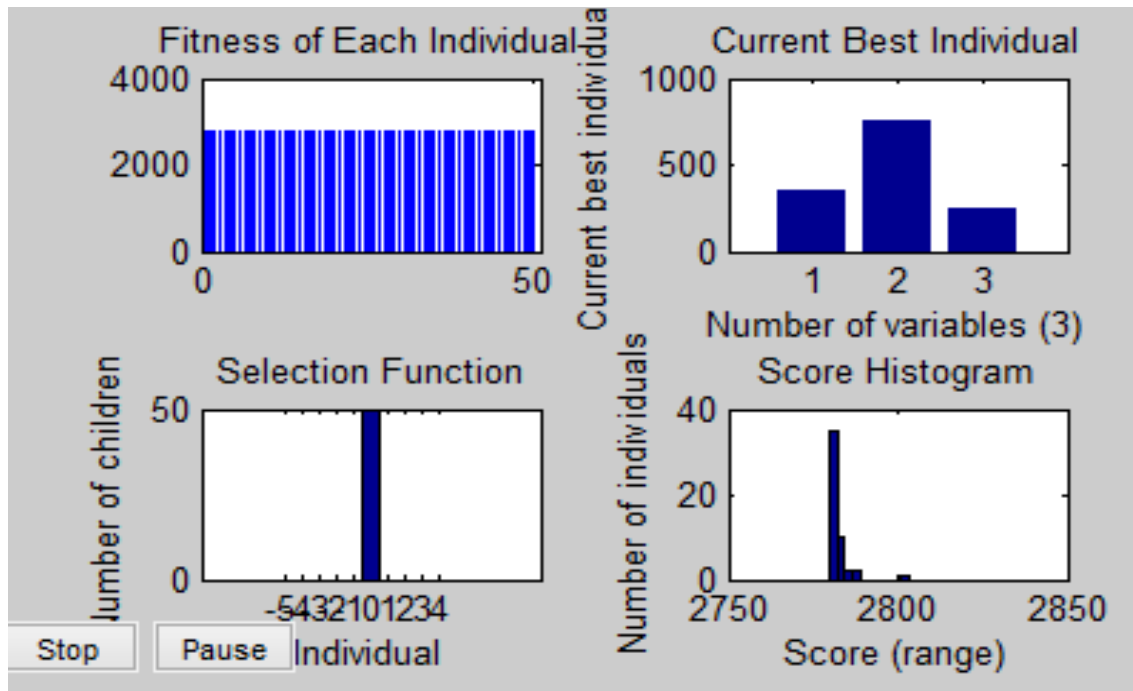

Fig. 8. Plots of optimization data for 2.0% reinforcement.

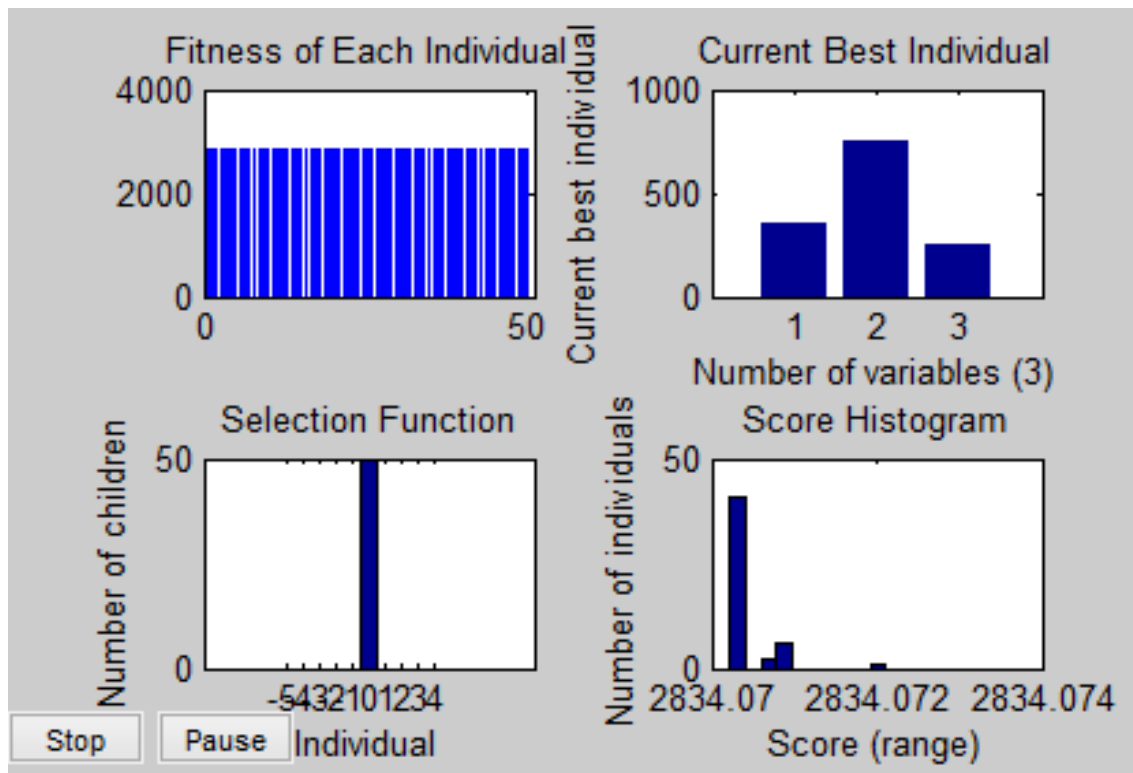

Fig. 9. Plots of optimization data for 2.5% reinforcement.

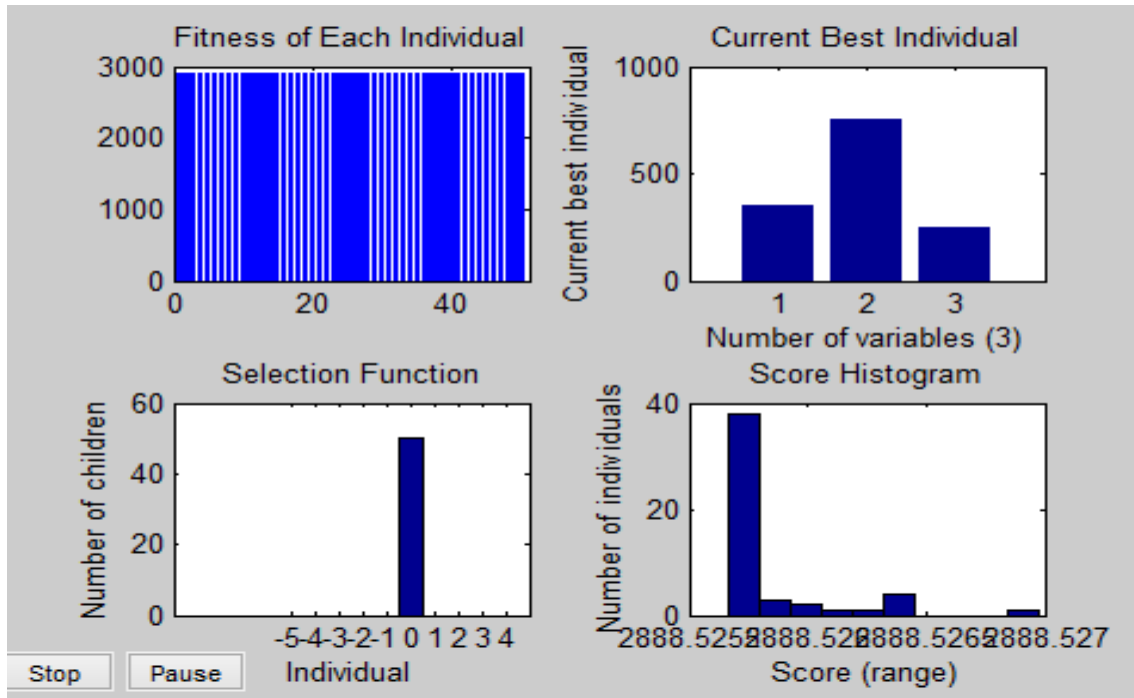

Fig. 10. Plots of optimization data for 3.0% reinforcement.

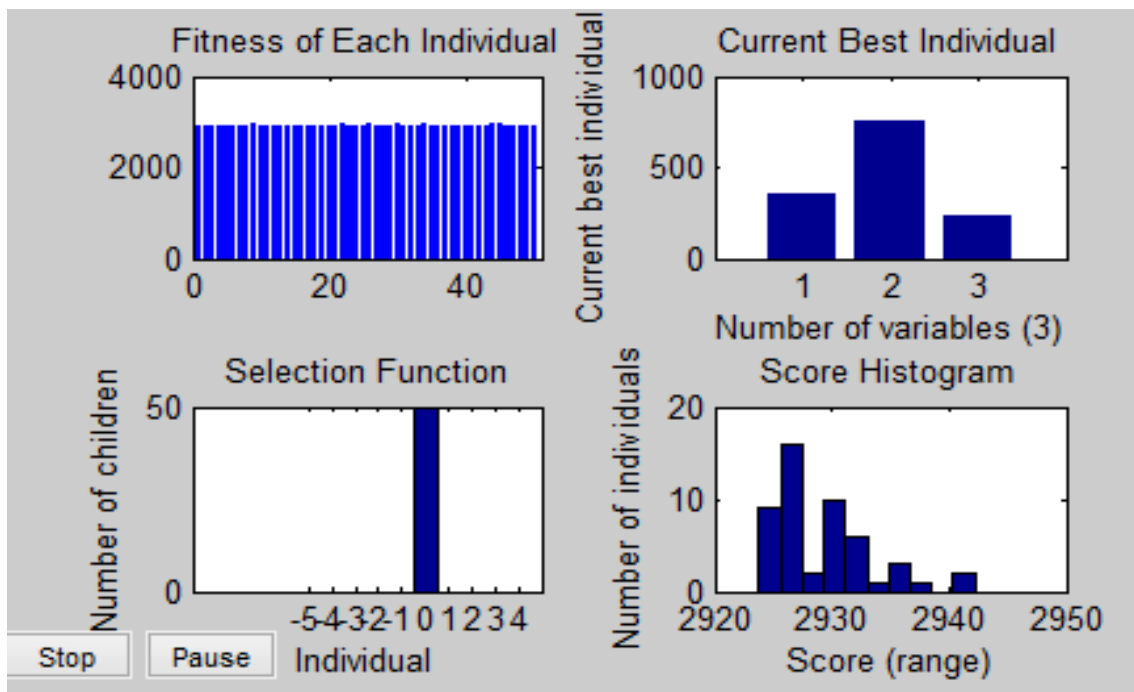

Fig. 11. Plots of optimization data for 3.25% reinforcement.

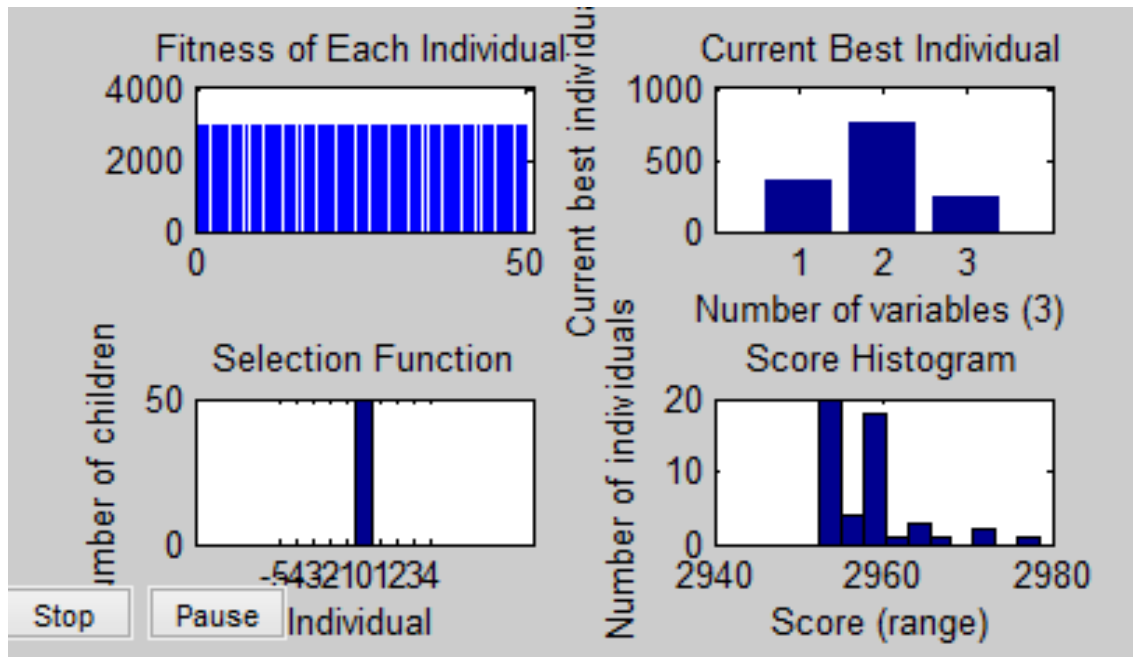

Fig. 12. Plots of optimization data for 3.5% reinforcement.

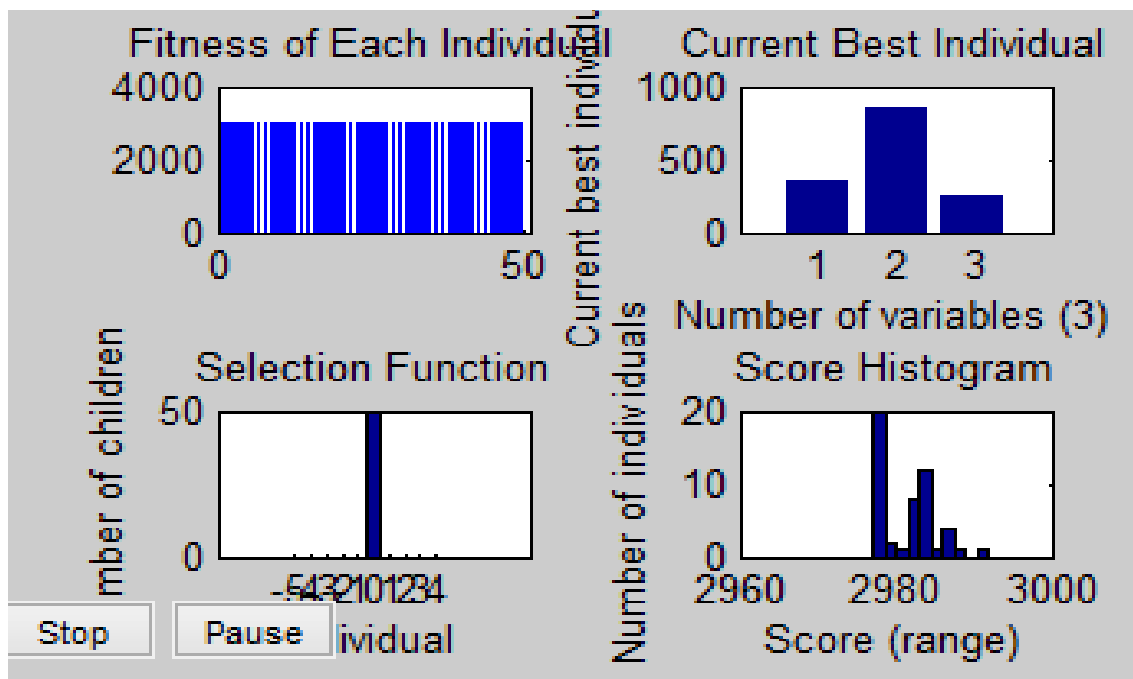

Fig. 13. Plots of optimization data for 3.75% reinforcement.

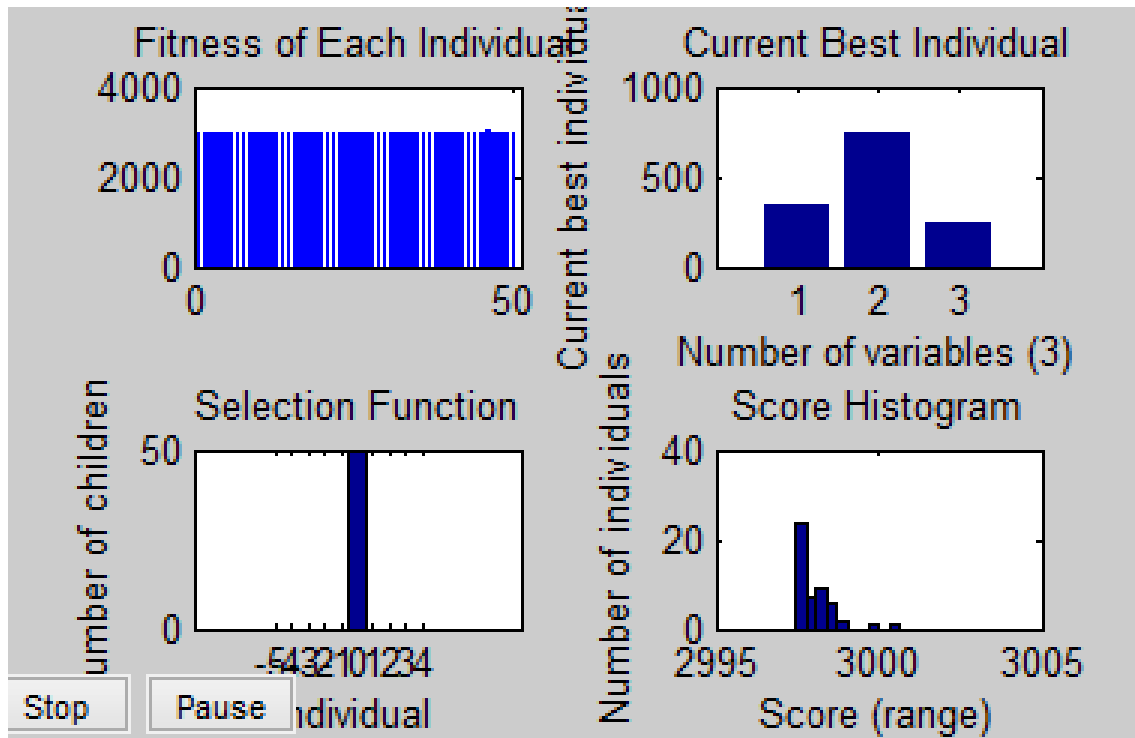

Fig. 14. Plots of optimization data for 4.0% reinforcement.

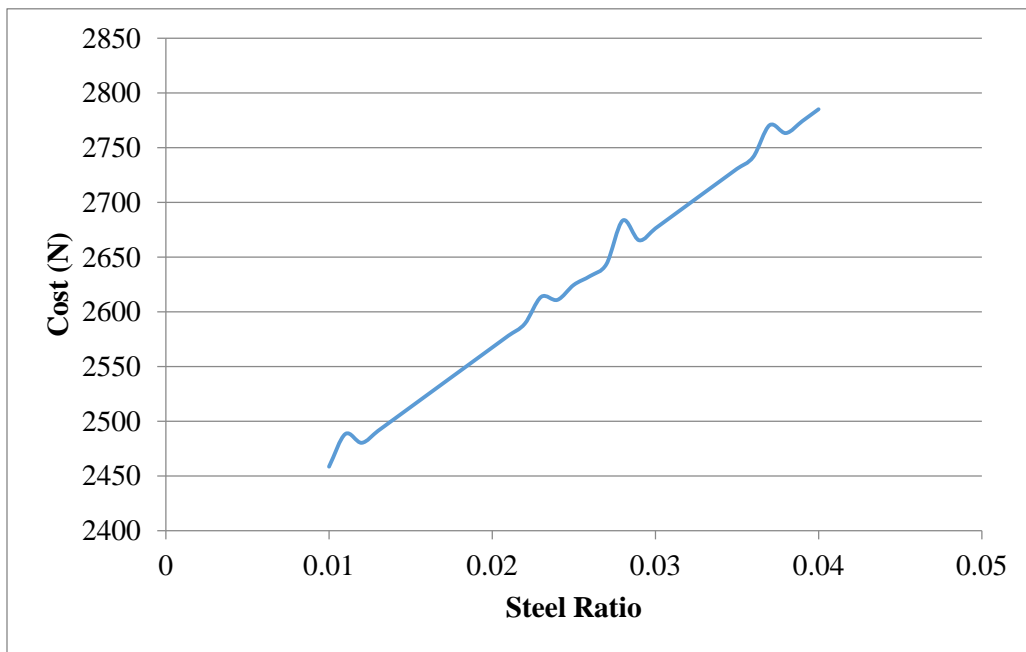

Fig. 15. Plot of optimized cost with steel ratio.

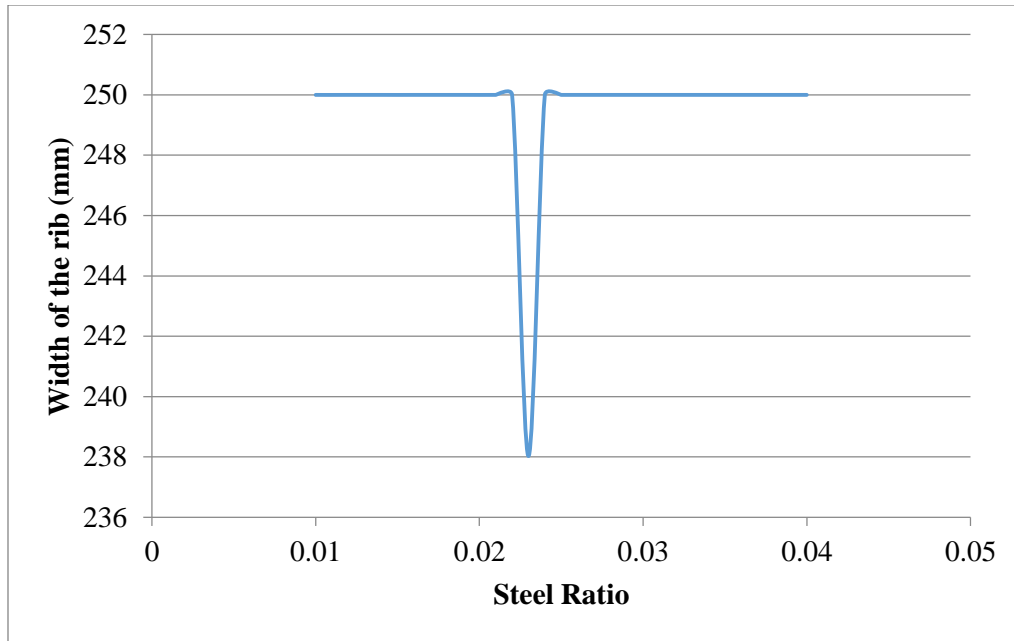

Fig. 16. Plot of optimized width of rib with steel ratio.

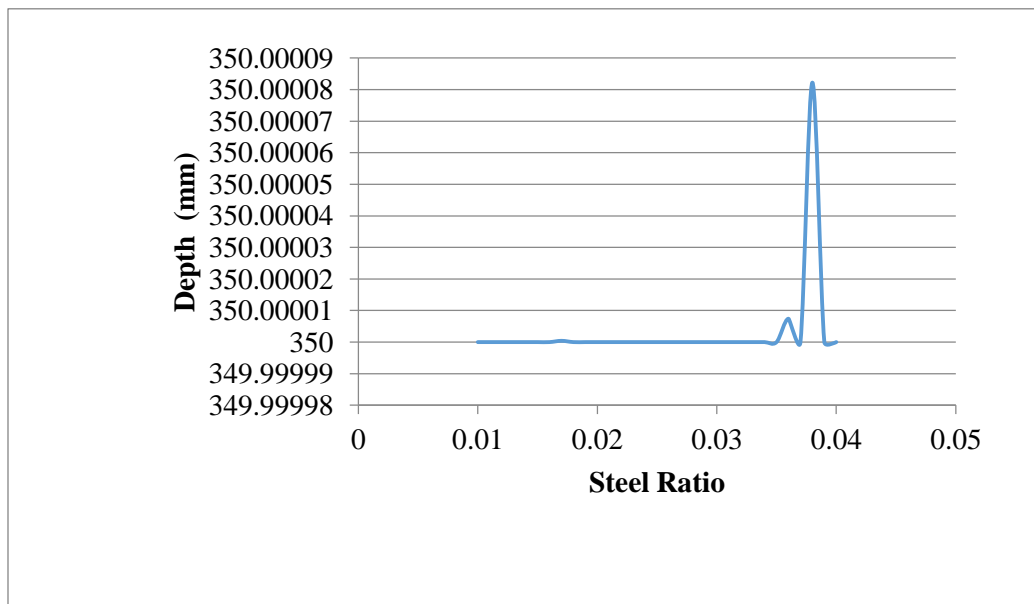

Fig. 17. Plot of optimized depth with steel ratio.

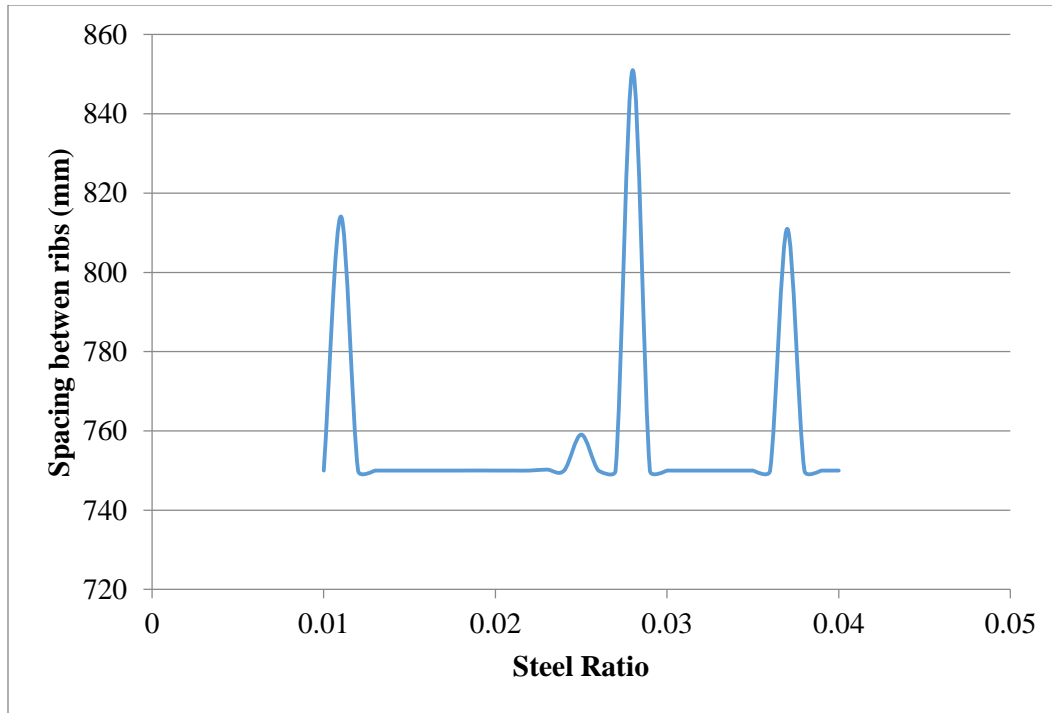

Fig. 18. Plot of optimized spacing between ribs with steel ratio.

#### 4. Conclusion

The objective function of the optimization problem which is the cost function for the reinforced concrete waffle slab has been fully established as described in equation 3. The design constraints of waffle slab design have been fully established in accordance BS 8110 part 1.

The adequacy of genetic algorithm method in optimizing the design of waffle slab was demonstrated in this research. The optimized steel ratio stood about 2.2% with the minimum values of slab dimensions being maintained. Thus, the objective function of the optimization problem for the reinforced concrete waffle slab was achieved. MATLAB scripts were written separately for the constraints and the genetic algorithm implementation of the cost function was carried out. Various plot functions were generated and the optimum design variable for the reinforced concrete waffles slab were obtained to be the depth of 500mm, rib width of 150mm, spacing between ribs of 1200mm with a reinforcement ratio of 3.5% and span to depth ratio of 20. The optimum reinforcement ratio was observed to be 3.5% with a thickness of 500mm, the rib width of 150mm and 1200mm and the span to depth ratio of around 20. Engineers should however ensure that the span to effective depth ratio of 20 is maintained when designing slab structures for an optimum cost. The reinforcement ratio of 3.5% was also observed to be more cost effective for the construction of reinforced concrete waffle slabs.

#### References

- [1] Tabatabai SMR, Mosalam KM. Computational platform for non-linear analysis/ optimal design of reinforced concrete structures. *Eng Comput* 2001;18:726–43. doi:10.1108/EUM000000005785.



- [2] GRIERSON DE. Practical optimization of structural steel frameworks in *Advances Design Optimization*, H. Adeli 1994.
- [3] Sahab MG, Ashour AF, Toropov VV. Cost optimisation of reinforced concrete flat slab buildings. *Eng Struct* 2005;27:313–22. doi:10.1016/j.engstruct.2004.10.002.
- [4] Varae H, Ahmadi-Nedushan B. Minimum cost design of concrete slabs using particle swarm optimization with time varying acceleration coefficients. *World Appl Sci J* 2011;13:2484–94.
- [5] Ahmadvkhanlou F, Adeli H. Optimum cost design of reinforced concrete slabs using neural dynamics model. *Eng Appl Artif Intell* 2005;18:65–72. doi:10.1016/j.engappai.2004.08.025.
- [6] Kaveh A, Talaei AS, Nasrollahi A. Application of Probabilistic Particle Swarm in Optimal Design of Large-Span Prestressed Concrete Slabs. *Iran J Sci Technol Trans Civ Eng* 2016;40:33–40. doi:10.1007/s40996-016-0005-4.
- [7] Gandomi AH, Yang X-S, Alavi AH. Cuckoo search algorithm: a metaheuristic approach to solve structural optimization problems. *Eng Comput* 2013;29:17–35. doi:10.1007/s00366-011-0241-y.
- [8] Kaveh A, Sh B. Optimum cost design of reinforced concrete one-way ribbed slabs using CBO, PSO and democratic PSO algorithms. *Asian J Civ Eng* 2014;15:788–802.
- [9] Akin A, Saka MP. Harmony search algorithm based optimum detailed design of reinforced concrete plane frames subject to ACI 318-05 provisions. *Comput Struct* 2015;147:79–95. doi:10.1016/j.compstruc.2014.10.003.
- [10] Senouci AB, Al-Ansari MS. Cost optimization of composite beams using genetic algorithms. *Adv Eng Softw* 2009;40:1112–8. doi:10.1016/j.advengsoft.2009.06.001.
- [11] Patil KS, Gore NG, Salunke PJ. Optimum design of reinforced concrete flat slab with drop Panel. *Int J Recent Technol Eng* 2013;2:37–9.
- [12] Galeb AC, Atiyah ZF. Optimum design of reinforced concrete waffle slabs. *Int J Civ Struct Eng* 2011;1:862–80.